



Collaborate



Control



Communicate



Converse



Quadra manufactures a multitude of lecterns, with every conceivable shape, style and material. From traditional to contemporary lecterns for lecture theatres, meeting rooms or houses of worship.

If you can't see the design you want, we will design and subject to your approval, manufacture it just for you.

We specialise in bespoke designs!



Classic Range

Definitive range of lecterns designed for university and college lecture theatres. The classic range is traditionally manufactured from wood and offered in a choice of single or double lectern styles.

Most lecterns can accommodate an equipment rack if required and we can incorporate 3D logos or room name signs as required.



Podiums for houses of worship and meeting rooms

A complete range of very different designs to suit churches, halls or meeting rooms. Models for this purpose include Premier, Pigo, Glaisdale, Electra (height adjustable), Linton and Crayke.

Height Adjustable Lectern

Description: FlexiMate M lectern

Mobile Height Adjustable Lectern for sit/stand working

New for 2024

Key Design Features

- Gas Assisted height adjustable mobile table lectern
- Tilt range 0° - 90° (14 segments)
- Height adjustment speed 2-5 seconds
- Height adjustment range 750mm - 1150mm (29-1/2"~45-1/4")
- Loading capacity - 10kgs
- Document Stopper

Product Code:

FLEXIMATE-M-W (White)

FLEXIMATE-M-B (Black)

Approximate size (mm)

750-1150 x 600 x 520 (HxWxD)

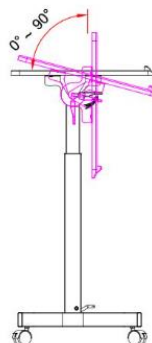
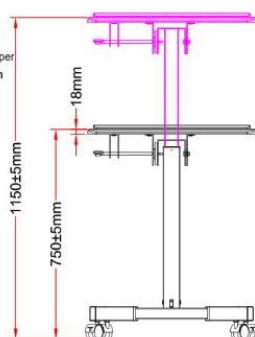
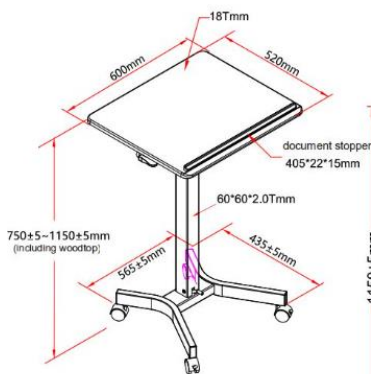

Portable Lecterns

Description: FlexiMate lectern Lectern/laptop table - sit or stand

Lightweight, easy to move yet stable and attractive. Affordable multi purpose telescopic lectern. Available in a huge range of colours. Lectern stands on a steel powder coated base. Conveniently height adjustable via lever 625mm-1050mm. Weight capacity 5kg standard tilt testing.

Product Code:
FLEXIMATE-MEL (melamine top)
FLEXIMATE-VEN (veneer top)

Approximate size (mm)
625-1050 x 510 x 380 (HxWxD)



Description: Piqo lectern S

The Piqo lectern is derived from the QC3255TR small screen trolley. Adjustable small shelf and worktop on the centre column via an Allen key. Locking carpet castors or feet. Centre column has a cable way throughout. Steel work is powder coated silver. The wooden tapered front panel, worktop and shelf can be in any standard melamine or veneer. Available in different RAL colours at additional cost.

Optional extras include vinyl logo, control panel housings and monitor arms (please see peripherals section for information and pricing)

Product Code:
PIQOLECTERN-S-MEL (melamine top)
PIQOLECTERN-S-VEN (veneer top)

Approximate size (mm)
1195 x 760 x 563 (HxWxD)



Description: Piqo lectern L

The Piqo lectern L is derived from the QC5585TR large screen trolley. Worktop is at a fixed height. Centre unit has removable panels for cabling. Fixed shelf and small cupboard. We can make this centre unit bespoke to you. Locking carpet castors or feet. Centre column has a cable way throughout. Steel work is powder coated silver. The wooden T shaped front panel, worktop and centre unit can be in any standard melamine or veneer. Available in different RAL colours at additional cost.

Optional extras include vinyl logo, control panel housings and monitor arms (please see peripherals section for information and pricing)

Product Code:
PIQOLECTERN-L-MEL (melamine top)
PIQOLECTERN-L-VEN (veneer top)

Approximate size (mm)
1200 x 1200 x 720 (HxWxD)



Classic Lecterns

Description: Danby lectern - rack or shelf with flat worktop

The Danby lectern is an off the shelf unit with a flat worktop and pull out keyboard drawer. Internal options can be as standard 16U 19" rack strips to the front, Quadra open frame rack or adjustable shelves.

Large range of melamine and veneer finishes available.

Optional extras include 10U, 12U or 16U open frame rack, vinyl logo, folding side mounted laptop shelf, control panel housings and monitor arms (please see peripherals section for information and pricing)

These are generally in stock in oak melamine for next day dispatch.

Product Code:

DANBY-SH-MEL (adjustable shelves)
DANBY-16U-MEL (16u rack strip or OFR)
DANBY-SH-VEN (adjustable shelves)
DANBY-16U-VEN (16u rack strip or OFR)

Approximate size (mm)
1137 x 573 x 624 (HxWxD)



Description: Hutton lectern

A classic style traditional lectern.

Fixed internal shelf. Lectern top conveniently angled with steel document stop. 4x carpet castors 2x locking.

Large range of melamine and veneer finishes available.

Optional extras include vinyl logo, folding side mounted laptop shelf and monitor arms (please see peripherals section for information and pricing)

Product Code:

HUTTON-MEL
HUTTON-VEN

Approximate size (mm)
1218 x 640 x 530 (HxWxD)



Description: Desktop classic lectern

The classic desktop lectern can be tailored to suit your requirements, from a flat worktop to a sloping one as per the image. We can alter the front under the worktop to suit either a pull out keyboard drawer or 4-6u rack space depending on the height of desking this will be sat on.

Large range of melamine and veneer finishes available

Product Code:

CLASSIC-DTLEC-MEL
CLASSIC-DTLEC-VEN

Approximate size (mm)
400 x 686 x 670 (HxWxD)



Description: Classic lectern

The classic lectern can be tailored to suit your requirements, from a flat worktop or a sloping top option. The larger image shows a pull out keyboard drawer however the maximum rack you can have is a 12U in the cabinet below. Internal options are our Quadra open frame rack or adjustable shelves.

Large range of melamine and veneer finishes available.

Optional extras include 10U, 12U, 16U open frame rack, vinyl logo, folding side mounted laptop shelf, control panel housings and monitor arms (please see peripherals section for information and pricing)

Product Code:

CLASSIC-SIN-LEC-MEL
CLASSIC-SIN-LEC-VEN

Approximate size (mm)
1200 x 686 x 715 (HxWxD)



Classic Lecterns

Description: Double classic lectern

The worktop can be flat as per image or you can have a full/split sloping top. Conveniently angled with steel document stop and cut outs for monitors. 2x 80mm grommet holes top and bottom. 2 compartments for Quadra open frame rack or shelves. Lockable doors fitted with fully adjustable hinges. Keyboard drawer can be fitted above shelves or 10U and 12U racks. Removable front panel. 4 swivel carpet castors.

Large range of melamine and veneer finishes available.

Optional extras include 10U, 12U or 16U open frame racks, folding side mounted laptop shelf, control panel housings and monitor arms (please see peripherals section for information and pricing) .

Product Code:

CLASSIC-DOU-LEC-MEL

CLASSIC-DOU-LEC-VEN

Approximate size (mm)

1220 x 1260 x 715 (HxWxD)



Description: Malham lectern (formally the D11)

The Malham lectern. Removable front panel fitted on keku clips for ease of access. Internal space for Quadra open frame rack. Storage space to the opposite side of rack for tower PC. Lockable doors fitted with fully adjustable hinges. Full length retractable keyboard drawer. Ventilation grills to either side of the lectern. 4x swivel carpet castors. Full width flat worktop. 2x 80mm cable grommets in each rear corner. Large range of melamine and veneer finishes available.

Optional extras include 10U or 12U open frame racks, vinyl logo, folding side mounted laptop shelf, control panel housings and monitor arms (please see peripherals section for information and pricing)

Product Code:

MALHAM-MEL

MALHAM-VEN

Approximate size (mm)

1220 x 990 x 715 (HxWxD)



Description: Hovingham lectern

Designed to promote your brand.

Delivered fully assembled. Adjustable perspex shelf for a glass of water or other items when in use. Lectern top conveniently angled with steel document stop. 4x carpet glides.

Product Code:

HOVINGHAM-MEL

HOVINGHAM-VEN

Approximate size (mm)

1165 x 580 x 415 (HxWxD)



Description: Linton portable lectern

A stylish portable lectern

This lectern is light and easy to move. Quick and easy to dismantle to carry or store.

The lectern top conveniently angled for the presenter. Linton is stable and rigid

when assembled. Easily breaks down into 4 components.

Large range of melamine and veneer finishes available.

Optional extras include a nylon or polyester carrying case (please see peripherals section for information and pricing)

Product Code:

LINTON-MEL

LINTON-VEN

LINTON-BAG-PY (Polyester carry bag)

LINTON-BAG-NY (Nylon carry bag)

Approximate size (mm)

890 x 550 x 450 (HxWxD)



Classic and Contemporary Lecterns

Description: Crayke lectern

A traditional yet modern design that is attractive, stable and functional lectern. The lectern top conveniently angled with steel document strip. Cut outs can be provided for lights, mics or control panels. The lectern stands on 4x carpet glides. Large range of melamine and veneer finishes available.

Product Code:

CRAYKE-MEL
CRAYKE-VEN

Approximate size (mm)
1065 x 800 x 655 (HxWxD)



Description: Glaisdale lectern

Delivered fully assembled. Lockable doors fitted with fully adjustable hinges. The lectern top conveniently angled with steel document stop. The cable ways are via 80mm cable grommet holes top and bottom. Four swivel carpet castors fitted (2x Locking).

Large range of melamine and veneer finishes available.

Optional extras include vinyl logo and folding side mounted laptop shelf (please see peripherals section for information and pricing)

Product Code:

GLAISDALE-MEL
GLAISDALE-VEN

Approximate size (mm)
1255 x 890 x 660 (HxWxD)



Description: Electra height adjustable lectern

This Lectern can accommodate a large touch screen display with integral PC (to be supplied by your integrator). Centre column retracts providing 200mm of height adjustment via a switch. A standard lectern top can be provided if required. Fitted with carpet glides. Exceptionally stable.

Large range of melamine and veneer finishes available.

Optional extras include control panel housings and monitor arms (please see peripherals section for information and pricing)

Product Code:

ELECTRA-MEL
ELECTRA-VEN



Approximate size (mm)
925-1125 x 835 x 520 (HxWxD)



Description: Solid dark oak pedestal lectern

Manufactured from solid oak. Raised and fielded panels on 3 sides of the column and the front panel of the lectern top which faces the audience. Pull out keyboard drawer under the worktop. Adjustable shelves in pedestal or option for rack strip. Door is on fully adjustable hinges with touch latch. Locking castors. Plinth either side and audience.

Product Code:

SON-PED-LEC (Dark colour Oak)
SOS-PED-LEC (Oak Stained Medium Oak)

Approximate size (mm)
1270 x 697 x 600 (HxWxD)



Premier Lecterns

Description: Premier N pedestal lectern

2x locking castors to the user's side. Flat worktop with cable grommet. Pull out keyboard or can have rack strip fitted. (we can alter the design to fit rack size in U)
Small adjustable shelves in the column.

Large range of melamine and veneer finishes available.

Product Code:

PREMIER-N



Description: Premier pedestal lectern

2x locking castors to the user's side. Flat worktop with cable grommet. Small adjustable shelves in the column.

Large range of melamine and veneer finishes available.

Optional extras include control panel housings and monitor arms (please see peripherals section for information and pricing)

Product Code:

PREMIER

Approximate size (mm)

1130 x 800 x 500 (HxWxD)



Description: Premier pedestal lectern 1

2x locking castors to the user's side. Sloping control panel fitted onto the flat worktop for your controllers. Pull out keyboard drawer within the worktop. Small adjustable shelves in the column.

Large range of melamine and veneer finishes available.

Optional extras include control panel housings and monitor arms (please see peripherals section for information and pricing)

Product Code:

PREMIER1

Approximate size (mm)

1215 x 1000 x 700 (HxWxD)



Description: Premier pedestal lectern 2

2x locking castors to the user's side. Sloping control panel fitted onto the flat worktop for your controllers. Pull out keyboard drawer within the worktop. Storage shelf & 10u rack strip in the column.

Large range of melamine and veneer finishes available.

Optional extras include control panel housings and monitor arms (please see peripherals section for information and pricing)

Product Code:

PREMIER2

Approximate size (mm)

1230 x 1000 x 700 (HxWxD)



Description: Premier Height Adjustable pedestal lectern

Electrically operated height adjustable Premier lectern.

This is based on the standard lectern. Raised and lowered with an electric lift. Flat worktop that can be lifted off for wiring etc. Cut outs throughout lectern for cable access. 4x swivel castors, 2x locking.

Large range of melamine and veneer finishes available.

Optional extras include control panel housings and monitor arms (please see peripherals section for information and pricing)

Product Code:

PREMIER-H/ADJ

Approximate size (mm)

860-1290 x 800 x 520 (HxWxD)



Comprehensive range available

Acoustics
Book 1, 2024



All fixtures, cabinets, media walls, video walls, collaboration tables, huddle spaces, boardrooms and meeting rooms tables, control desks, server racks, screen stands, trolleys and sound management solutions to name a few.

Classic & Contemporary Lecterns
Book 2, 2024



All fixtures, cabinets, media walls, video walls, collaboration tables, huddle spaces, boardrooms and meeting rooms tables, control desks, server racks, screen stands, trolleys and sound management solutions to name a few.

Educational Lecterns
Book 3, 2024



All fixtures, cabinets, media walls, video walls, collaboration tables, huddle spaces, boardrooms and meeting rooms tables, control desks, server racks, screen stands, trolleys and sound management solutions to name a few.

AV Cabinets & Credenzas
Book 4, 2024



All fixtures, cabinets, media walls, video walls, collaboration tables, huddle spaces, boardrooms and meeting rooms tables, control desks, server racks, screen stands, trolleys and sound management solutions to name a few.

Tables and Desks
Book 5, 2024



All fixtures, cabinets, media walls, video walls, collaboration tables, huddle spaces, boardrooms and meeting rooms tables, control desks, server racks, screen stands, trolleys and sound management solutions to name a few.

Control room & Enquiry rooms
Book 6, 2024

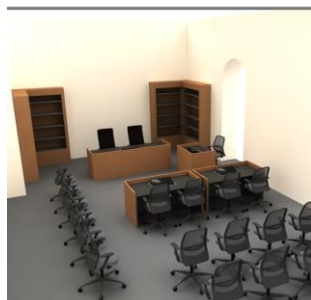

All fixtures, cabinets, media walls, video walls, collaboration tables, huddle spaces, boardrooms and meeting rooms tables, control desks, server racks, screen stands, trolleys and sound management solutions to name a few.

Media Walls & Screen Surrounds
Book 7, 2024



All fixtures, cabinets, media walls, video walls, collaboration tables, huddle spaces, boardrooms and meeting rooms tables, control desks, server racks, screen stands, trolleys and sound management solutions to name a few.

Collaboration Tables & Screen towers
Book 8, 2024

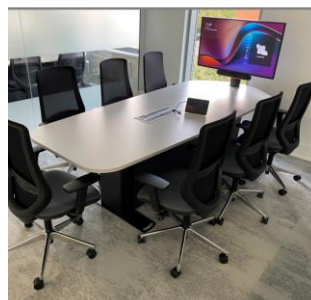

All fixtures, cabinets, media walls, video walls, collaboration tables, huddle spaces, boardrooms and meeting rooms tables, control desks, server racks, screen stands, trolleys and sound management solutions to name a few.

Media & Signage Towers
Book 9, 2024

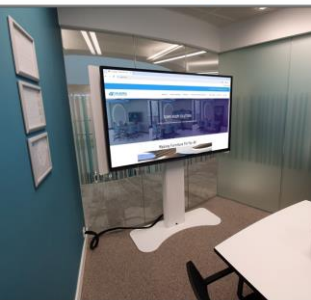

All fixtures, cabinets, media walls, video walls, collaboration tables, huddle spaces, boardrooms and meeting rooms tables, control desks, server racks, screen stands, trolleys and sound management solutions to name a few.

Piigo Trolleys & Stands
Book 10, 2024



All fixtures, cabinets, media walls, video walls, collaboration tables, huddle spaces, boardrooms and meeting rooms tables, control desks, server racks, screen stands, trolleys and sound management solutions to name a few.

Kaigi Booths
Book 11, 2024



All fixtures, cabinets, media walls, video walls, collaboration tables, huddle spaces, boardrooms and meeting rooms tables, control desks, server racks, screen stands, trolleys and sound management solutions to name a few.

Connectivity
Book 12, 2024



All fixtures, cabinets, media walls, video walls, collaboration tables, huddle spaces, boardrooms and meeting rooms tables, control desks, server racks, screen stands, trolleys and sound management solutions to name a few.

Task & Meeting Chairs
Book 13, 2024



All fixtures, cabinets, media walls, video walls, collaboration tables, huddle spaces, boardrooms and meeting rooms tables, control desks, server racks, screen stands, trolleys and sound management solutions to name a few.

Teams Room Furniture
Book 14, 2024



All fixtures, cabinets, media walls, video walls, collaboration tables, huddle spaces, boardrooms and meeting rooms tables, control desks, server racks, screen stands, trolleys and sound management solutions to name a few.

Peripherals
Book 15, 2024



All fixtures, cabinets, media walls, video walls, collaboration tables, huddle spaces, boardrooms and meeting rooms tables, control desks, server racks, screen stands, trolleys and sound management solutions to name a few.

Standard Finishes
Book 16, 2024

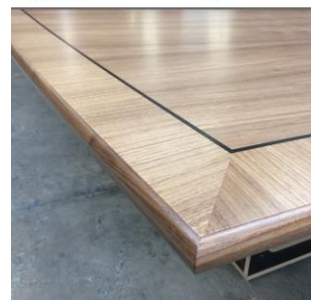

All fixtures, cabinets, media walls, video walls, collaboration tables, huddle spaces, boardrooms and meeting rooms tables, control desks, server racks, screen stands, trolleys and sound management solutions to name a few.



About Us.

We design and install prebuilt and bespoke AV furniture, Media walls, lecterns, credenzas, stands, trolleys, cabinets, acoustic treatments and much more.

We do this using the latest professional CNC machinery and only the best core materials. Located in York with close access to the motorway network we are conveniently located to deliver and install across the UK.

Quadra AV Furniture Ltd
Head Office : Glaisdale Road,
Northminster Business Park,
Upper Poppleton, York, YO26 6QT

Web - www.qavf.co.uk
Telephone - 01904 528 519
Email - sales@qavf.co.uk

Your Local Quadra Partner:

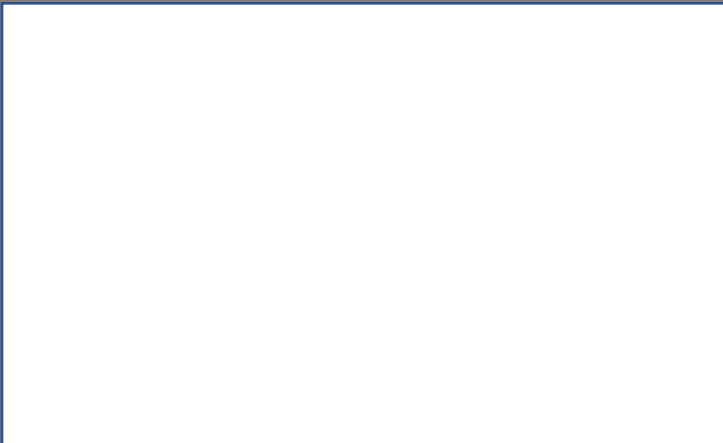

Quadra Concepts UK Limited trading as Quadra AV Furniture is registered in England and Wales.
Reg No. 06322818 – VAT No. GB 916 3405 38

